

Indomo[®] Multipurpose Homelift





InDomo

ACCESSIBLE MOBILITY

Why a home lift?

Our home lifts are designed to solve the needs of vertical mobility and to remove architectural barriers in all environments, both private and public.

They represent the ideal solution to overcome the stairs and rediscover the pleasure of moving freely in every moment of the day.

They can be installed both inside and outside the building in special metal structures or between the walls of the house.

They ensure a high level of ride comfort, great reliability and total safety, for example guaranteed by the automatic emergency lowering system in the event of a power failure.

They can be installed in new buildings but perfectly fit any existing environment, increasing their value.

Safety

Thanks to the wide range of specific devices you can move around the house everyday without worries.

Comfort

It can be operated by pressing the button, both in the cabin and on the landings. Choosing the version with automatic sliding or folding doors in the car, you will not have to hold the button pressed during the entire travel.

Stile

Decorate the space in motion by choosing the finishes that best suit your environments and satisfy your taste as you would do for any furnishing accessory. Our renewed range of cabins, Smart - Idea - Style and Opera, best represents the expression of MADE IN ITALY.

InDomo

Indoor and outdoor homelifts

InDomo can be installed both inside and outside the building to ensure maximum accessibility at all levels.

If you do not have a specific shaft you can connect the lift directly to the balcony or use existing windows, modified to obtain the necessary entrances.



Small elevators for private homes and public environments

Our products find their natural connotation mainly in private homes to help you live fully your environments.

Nevertheless, they are the ideal solution to overcome architectural barriers in public environments like schools, shops, restaurants, offices, and can guarantee the right solution to all needs.







InDomo

Masonry shaft or metallic structure

The lift travels inside a shaft to guarantee the maximum safety, according to the existing regulations law. The shaft can be obtained inside the house making it in masonry or concrete.

Alternatively we can provide a metal structure designed for indoors or outdoors (since it is weather-proof), certified according to the anti-seismic rules. The structure has multiple finishes and can be completely glazed to ensure good aesthetic results, lightness and visibility.

Swing doors or automatic doors

As standard, InDomo lifting platforms are offered with swing glazed doors that guarantee maximum visibility and passive safety.

They can also be equipped with automatic sliding doors or with internal folding doors and external automatic swing doors (MyDomo) which allow automatic control to avoid having to keep the button pressed during the entire travel.



Cabin Smart

Beauty and simplicity

With its up to date, minimalist and yet affordable design, this is LiftingItalia best selling cabin, now available with new eye catching skinplate texture finishes.



**Full height COP
in scotch brite ST/ST**



Cabin Idea

Elegance and flexibility

Bright, fresh and available in a wide range of colors, this cabin boasts a plain and youthful design that brings sparkle to its surroundings. IDEA is the cabin designed specifically for panoramic lifts and offers the possibility of having up to three glass walls.

Full height COP in anodized aluminum

Internal car profiles in anodized aluminum

External wall cladding in anodized aluminum



Cabin Style

Timeless style

The material combinations are designed to elevate the enduring look of the stainless steel, which enhances both classic and modern environments.



Full height COP in polished Mirror ST/ST



Cabin Opera

Warmth and accessible luxury

We chose a selection of the most interesting contemporary design materials, to create a uniquely refined cabin design.

3/4 height COP
in anodized aluminum

Internal car profiles
in anodized aluminum

External wall cladding
in anodized aluminum





Doors

LINE DOOR

Single panel swing door

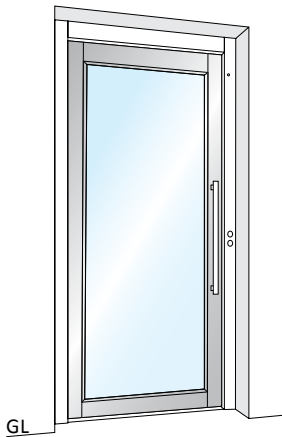

Aluminium
Handle
Height 700 mm
Cod. ML.05
(Standard)

Single panel swing door;
**manual opening and automatic
closing.**

Available versions:

- GL (glazed - standard)

- Landing door finishes:

**Silver anodized aluminium
(standard) and Painted steel**



Stainless Steel
Handle
Height 700 mm
Cod. ML.06
(Optional)

AUTOMATIC DOORS KIT MYDOMO-PACK

Double panels swing automatic landing door

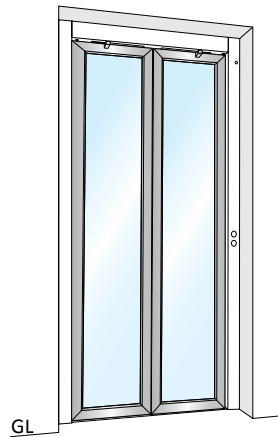

Double panels swing landing door coupled with a
folding car door **completely automatic in opening
and closing** operations. A safety device stops the
movement in case of obstruction.

MyDomo landing door and Twist folding car door
are also available:

- BL (blind)

- GL (glazed)

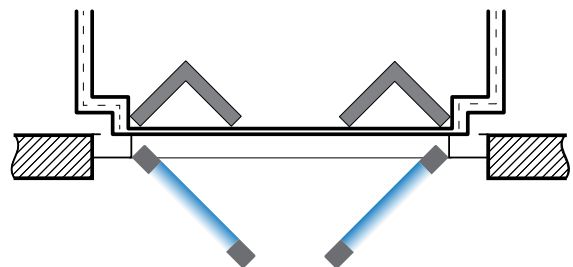



2 PANELS AUTOMATIC

Centre opening door

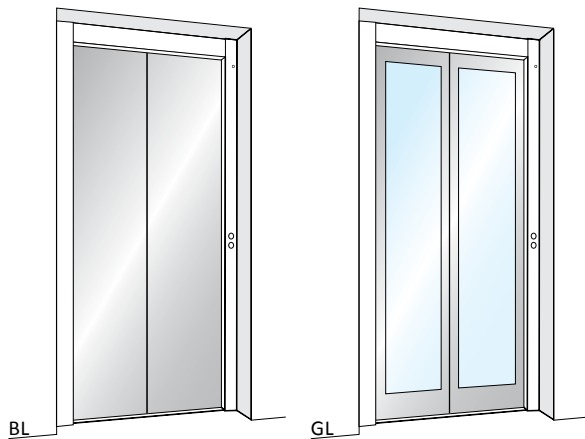

Car and landing 2 panels **automatic centre opening** door with safety device to re-open in case of obstructions.

Versions:

- BL (blind) - standard
- GL (glazed)

Available also:

- Fire rated E120
- Fire proof EI120

- Standard finishes:
F12PPS - A80SMA - PPS10 - DT 65 Skinplate
- Optional finishes:
Stainless Steel and Painted steel
- Entry-level finish:
RAL 7032 smooth and repaintable primer

2 PANELS AUTOMATIC

Side opening door

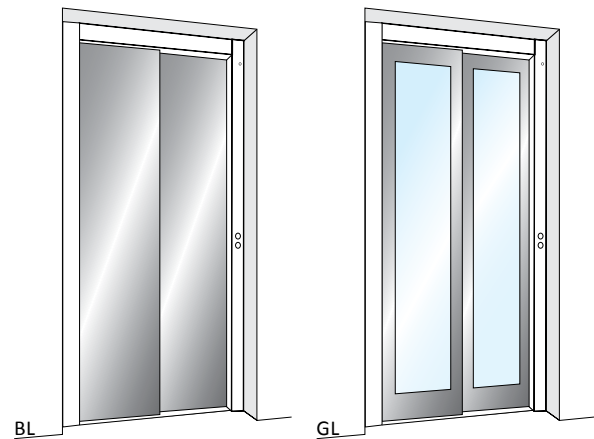

Car and landing 2 panels **automatic side opening** door with safety device to re-open in case of obstructions.

Versions:

- BL (blind) standard
- GL (glazed)

Available also:

- Fire rated E120
- Fire proof EI120

- Standard finishes:
F12PPS - A80SMA - PPS10 - DT 65 Skinplate
- Optional finishes:
Stainless Steel and Painted steel
- Entry-level finish:
RAL 7032 smooth and repaintable primer

COP

COP STANDARD CONFIGURATION

- Braille push buttons
- Alarm button
- Luminous and acoustic overload signal
- Door open push button (only with automatic doors)
- Emergency STOP button (only without car doors)
- Emergency light
- Two-way intercom

PUSH BUTTONS

- The push button (Ø 29,6 mm) features Braille code
- Blue backlight
- Dimensions with bezel 42 × 38 mm
- Matt stainless steel/gold finish



OPTIONS

- Enabling key
- Magnetic iButton key
- Position and direction displays
- Phone dialler
- Wall phone
- In-built telephone box (where possible)
- LCD Display (5,6")
- TFT Display (7")



←
Embossed COP,
anodized aluminum,
3/4 height or full height

Width 220 mm
Depth 25 mm

→
Flush COP,
full height,
scotch brite or mirror
finish stainless steel

Width 220 mm

Display

LANDING DISPLAY - OPTIONAL



Car position
display
with frame
mounted
on the transom

On the wall
With metal
frame

CAR DISPLAY - OPTIONAL



TFT (7")
Without frame
Dimensions:
154 × 86 mm



Tricolor (5,6")
With metal frame
Dimensions:
120 × 60 mm

Ceilings

PLEXY CEILING

not backlighted (standard)



- Standard ceiling for **SMART - IDEA - OPERA** cars
- Standard finishes: **Scotch Brite Stainless Steel and Anodized aluminium**
- Optional finishes: **Mirror Stainless Steel**

COUNTER-CEILING QUADRO

backlighted

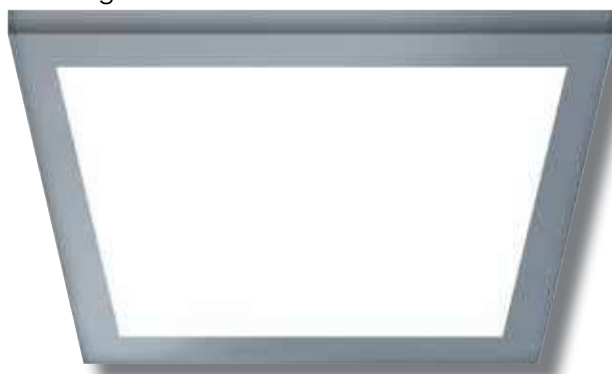

- Standard counter-ceiling for **STYLE** car
- Optional counter-ceiling for **SMART - IDEA - OPERA** cars
- Standard finishes: **Scotch Brite or Mirror Stainless Steel**

COUNTER-CEILING WINDOW

backlighted

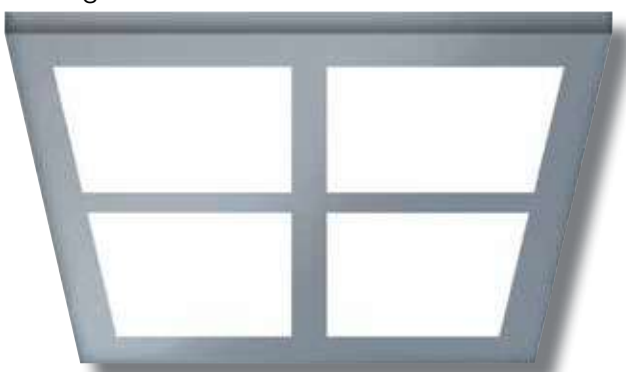

- Standard counter-ceiling for **STYLE** car
- Optional counter-ceiling for **SMART - IDEA - OPERA** cars
- Standard finishes: **Scotch Brite or Mirror Stainless Steel**

COUNTER-CEILING SPOTLIGHTS

with LED spot lights



- Standard counter-ceiling for **STYLE** car
- Optional counter-ceiling for **SMART - IDEA - OPERA** cars
- Standard finishes: **Scotch Brite or Mirror Stainless Steel**

Handrail

Modular aluminum handrails with the following finishes:

- natural anodized aluminum
Cod. CR.03
- aluminum stainless steel effect
Cod. CR.04



Cod. CR.03



Cod. CR.04

InDomo Finishes

Stainless Steel

For car walls and automatic doors



Satinato Gr. 240
Stainless Steel

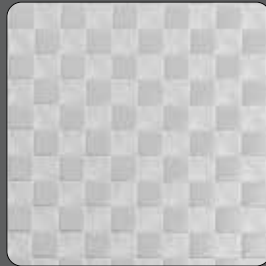

D21 Quadro
Stainless Steel



D25 Lino
Stainless Steel

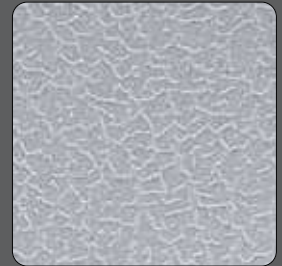

D42 Cuoio
Stainless Steel



Scotch Brite
Stainless Steel

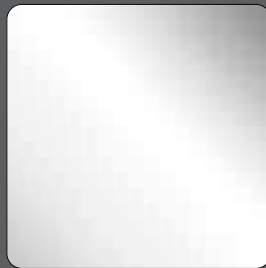

Lucido specchio
Stainless Steel

For LINE doors —

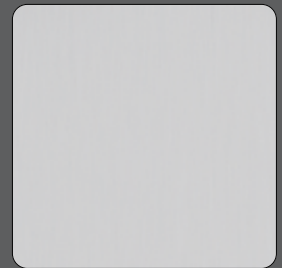

Anodized aluminium

Skinplate

For automatic door and IDEA and OPERA cars

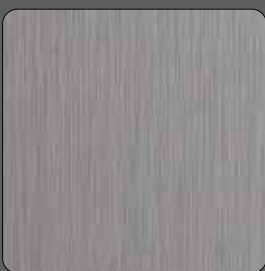

F12PPS
Stainless-Look



PPS10
Marble



DT 65
Grey Fabric

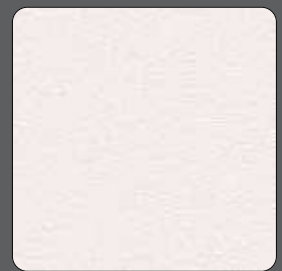

A80SMA
White Ice

For IDEA and OPERA cars



DT 63
Rough Fabric



DT 64
Kaki Fabric



A90GTA
Cream - Canvas effect



F21PVA
Dotted Silver

InDomo Finishes

Laminate HPL

MONOCHROMATIC FINISHES - For IDEA and OPERA cars

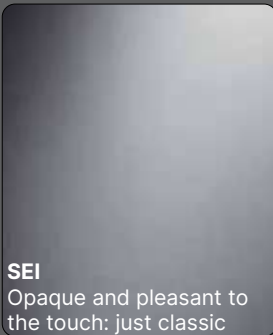
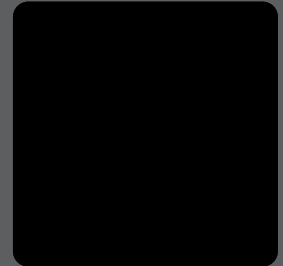

Laminate HPL

MATERIAL FINISHES - For IDEA and OPERA cars

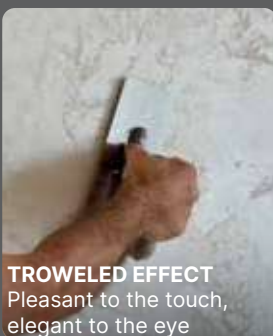
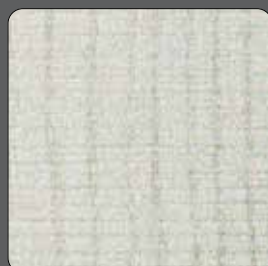

InDomo Finishes

Floors

GRANITE AGGLOMERATE



GRANIT 607
Polar Ice



GRANIT 431
White



GRANIT 2402
Dove Tail



GRANIT 646
Black Diamond



GRANIT 663
Vetro Moretti

ROUND STUDDED RUBBER



G804
Light Grey



N004
Black

PVC "ETERNAL COLLECTION"



13772
Eternal Brushed Aluminium

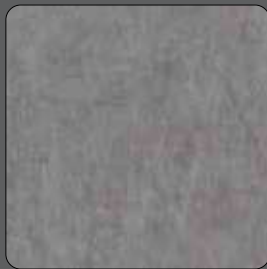

13712
Eternal Brushed Chrome



42292
Eternal Charcoal Slate



5 bar aluminium tread plate

ALUMINIUM

Glasses and mirrors



Natural
- Standard

Acid Etched

Natural
Milky White

Smoke Grey

Smoke Bronze

Bronze Stopsol

Mirror

InDomo Finishes

Paints

CRINKLED FINISH

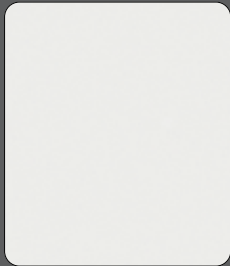

RAL 9010
Pure white

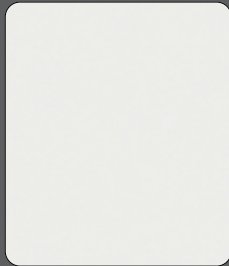

RAL 9016
Traffic white

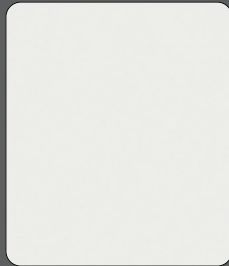

RAL 1013
Oyster white



DESERT ROSE
Sand

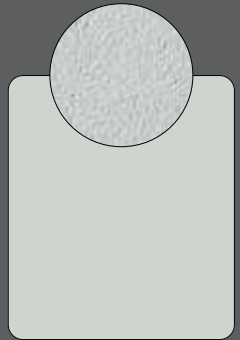

RAL 7035
Light grey

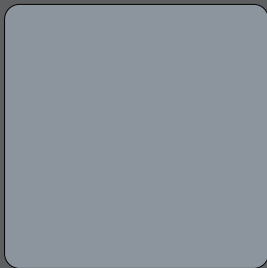

RAL 7001
Silver grey



RAL 9006
White aluminium



RAL 9007
Grey aluminium



GREY MICA
Grey mica



BLASTED COPPER
Copper



ANTIQUE RUST
Corten



RAL 8019
Grey brown



RAL 7016
Anthracite grey

SMOOTH FINISH



RAL 9005
Jet black



BRONZE - Y540NE3
Metallized Bronze



GOLD - K500Y08
Metallized Gold

OPTIONAL



RAL painting
Complete RAL range

InDomo

Overall installation configurations

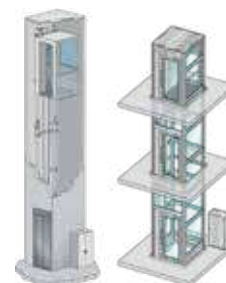

PRODUCT SPECIFICATIONS	InDomo
MAX PAYLOAD	500 kg
MAX TRAVEL	20 m
MAX ENTRANCES	3
MAX STOPS (in line)	8
SHAFT	
CONCRETE OR MASONRY	■
STEEL STRUCTURE, PAINTED RAL	□
STAINLESS STEEL STRUCTURE (AISI 304 or AISI 316 FOR MARINE ENVIRONMENT)	□
CARS	
SMART	■
STYLE	□
IDEA	□
OPERA	□
1 GLASS WALL	□
2 GLASS WALLS	□
CAR DOORS	
WITHOUT DOOR (with LIGHT CURTAIN)	■
AUTOMATIC SLIDING, 2-PANELS SIDE OPENING (BL-GL)	□
AUTOMATIC SLIDING, 2-PANELS CENTRE OPENING (BL-GL)	□
AUTOMATIC TWIST FOLDING 2-PANELS (BL-GL)	—
AUTOMATIC TWIST FOLDING 4-PANELS (BL-GL)	□
LANDING DOORS	
LINE GL - ALUMINIUM (GLAZED version)	■
IRON - STEEL (BL1)	□
MyDOMO pack (coupled with TWIST) (GL-BL)	□
AUTOMATIC SLIDING, 2-PANELS SIDE OPENING (BL-BL1-GL)	□
AUTOMATIC SLIDING, 2-PANELS CENTRE OPENING (BL-BL1-GL)	□
HYDRAULIC TRACTION	
Indirect acting 2:1	■
Side direct acting 1:1	☒

(1) available also E120 and FIRE RATED EI120 executions

LEGEND	■ Standard	☒ Option, no extra price	□ Optional	— Not available
	BL: BLIND version	GL: GLAZED version		

AVAILABLE ALSO WITH AISI 316 STRUCTURE FOR MARINE ENVIRONMENT

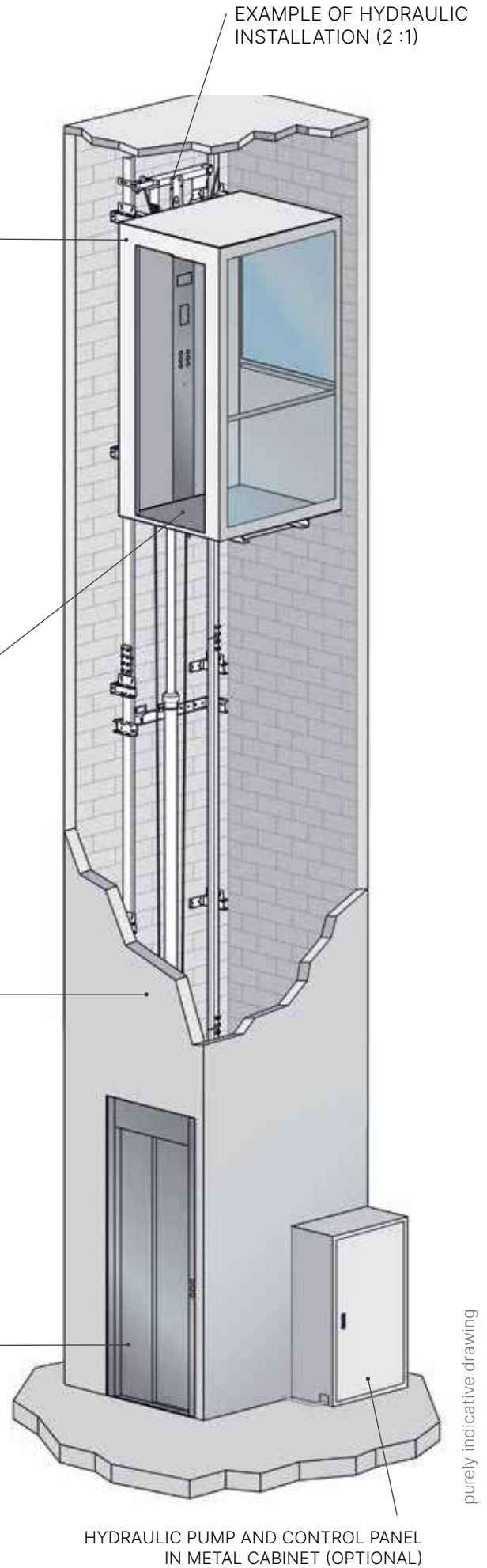
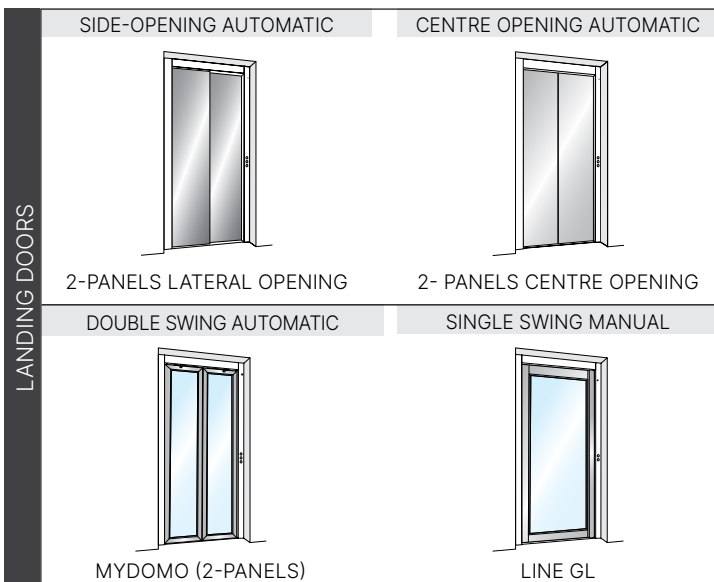
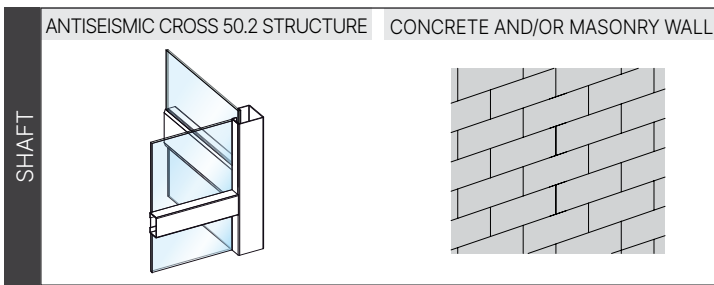
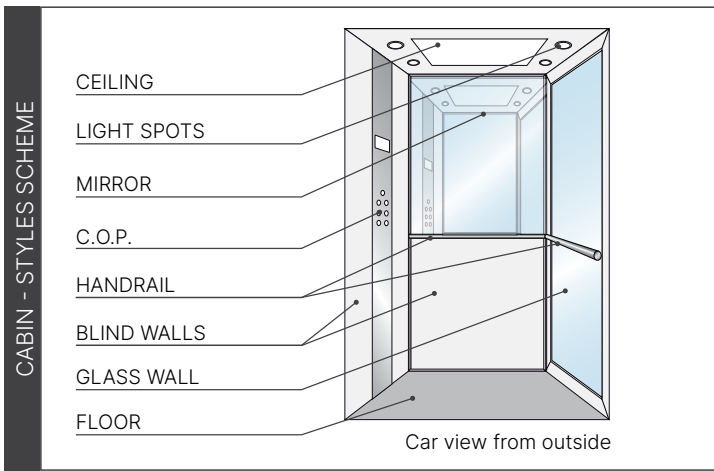
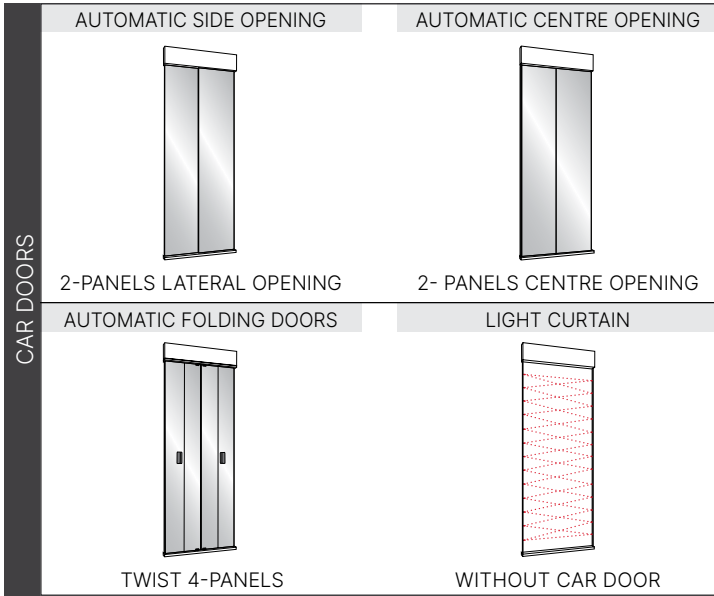



Outdoor



Indoor



Suggested
use



Suggested
use



Max payload
500 kg



230 VAC
single phase

STRENGTH AND RELIABILITY

InDomo means reliability and safety. Thanks to the hydraulic traction, to the solid structure and to the safety devices (blackout emergency descent, automatic rescue call and much more) you will never have to fear of being stuck in the cabin.

TOP COMFORT AT THE BEST PRICE

InDomo is the mini-lift for those who don't accept compromises. Top comfort and quietness, smooth starts and stops, great lighting and best technologies create the best travel experience in the category.

LIVING SPACE

The new range shows a completely renewed line of cabins, with a clean and essential design which will give your house an unmistakable touch of elegance.

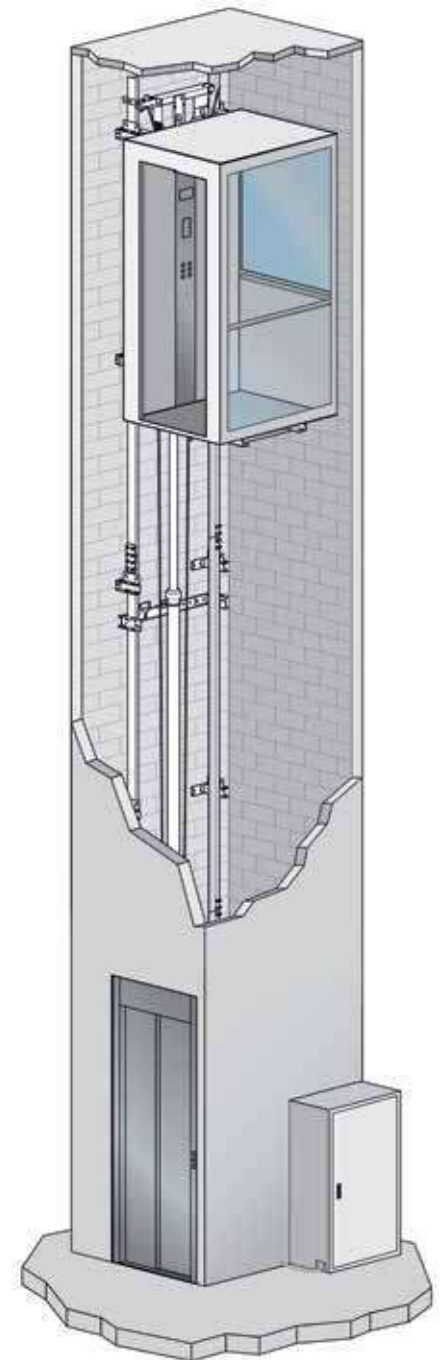

PAYLOADS	From 250 up to 500 kg
TRAVEL	Up to 20 m
STOPS	Up to 8 (in line)
ENTRANCES	Up to 3
SPEED	0,15 m/s (EU) - 0,30 m/s (extra-EU)
SHAFT	Masonry shaft or Anti-seismic structure
CONTROL	Hold to run or Automatic
NOISE LEVEL	Max. 47 dB
CABIN DIMENSION	Max. 1400 (L) x 2000 (P) *
CABIN HEIGHT (CH)	Std. 2100 mm (Min. 2000 - Max. 2200)
DOOR HEIGHT (LH)	Std. 2000 mm (Min. 1800 - Max. 2100)
HEADROOM (LH 2000)	Min. 2300 mm - Max. 2570 mm
PIT	Min. 100 mm - Max. 500 mm
CYCLES/HOUR SUGGESTED	15
POWER SUPPLY	Single phase 230 Vac (3-phase 400 Vac as option)
CONTROL PANEL AND HYDRAULIC SYSTEM	In metal cabinet (optional)
REFERENCE REGULATION	D.M. 2006/42/CE - EN81.41

CUSTOM DIMENSIONS WITH 5
MM STEPS

MIN DIMENSIONS

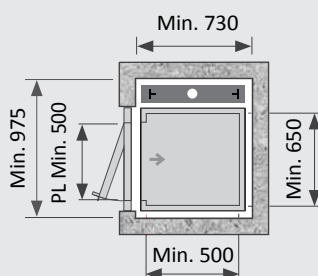

MAX DIMENSIONS

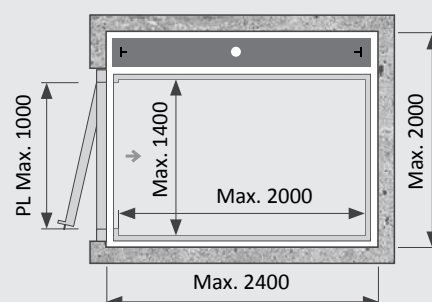

InDomo

metallic structure 50.2



Outdoor



Indoor



Suggested use



Suggested use



Max payload



230 VAC single phase

STRENGTH AND BEAUTY

CROSS 50.2 2 is a steel structure for lift and lifting platform, suitable to be placed both inside and outside the building, consisting of bolted uprights and connecting crosspieces, bolted, prepared for fixing glasses or panels from inside the structure. The CROSS 50.2 structures are tested according to the NTC2008 standards for installations in seismic zones. It has clean lines that suit all environments, both outdoor and indoor. Thanks to this structure, expensive masonry work is no longer necessary except for landing on the floor in case it was not planned.

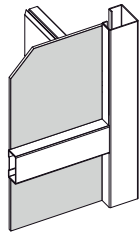

BL: blind version

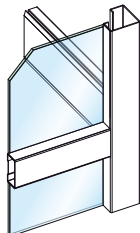

GL: glazed version

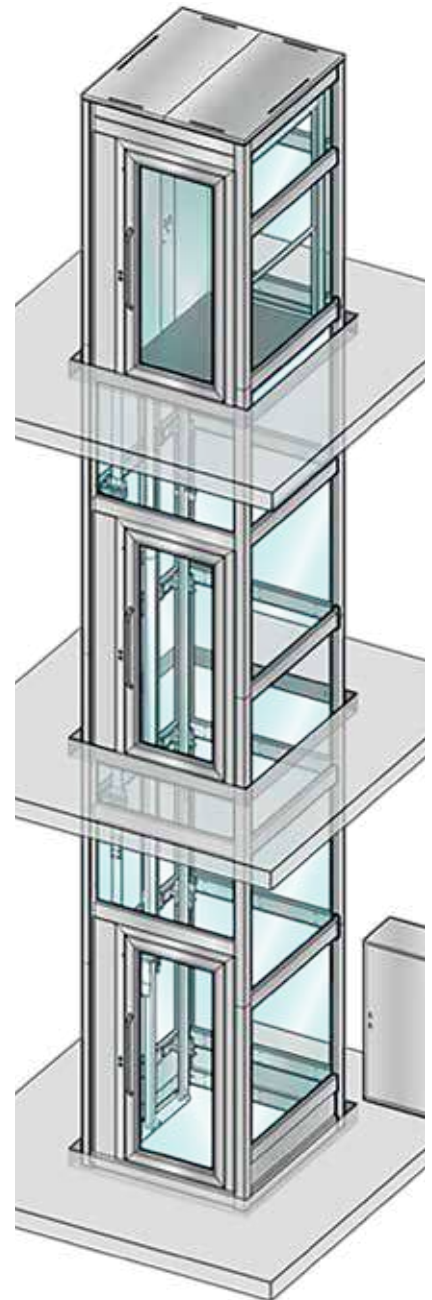

PAYLOADS	From 250 up to 500 kg
TRAVEL	Up to 20 m
STOPS	Up to 8 (in line)
ENTRANCES	Up to 3
SPEED	0,15 m/s (EU) - 0,30 m/s (extra-EU)
SHAFT	Masonry shaft or Anti-seismic structure
CONTROL	Hold to run or Automatic
NOISE LEVEL	Max. 47 dB
CABIN DIMENSION	Max. 1100 (L) x 1700 (P) *
CABIN HEIGHT (CH)	Std. 2100 mm (Min. 2000 - Max. 2200)
DOOR HEIGHT (LH)	Std. 2000 mm (Min. 1800 - Max. 2100)
HEADROOM (LH 2000)	Min. 2300 mm - Max. 2570 mm
PIT	Min. 100 mm - Max. 500 mm
CYCLES/HOUR SUGGESTED	15
POWER SUPPLY	Single phase 230 Vac (3-phase 400 Vac as option)
CONTROL PANEL AND HYDRAULIC SYSTEM	In metal cabinet (optional)
REFERENCE REGULATION	D.M. 2006/42/CE - EN81.41

CUSTOM DIMENSIONS WITH 5 MM STEPS

AVAILABLE WITH STAINLESS STEEL AISI316

MIN DIMENSIONS

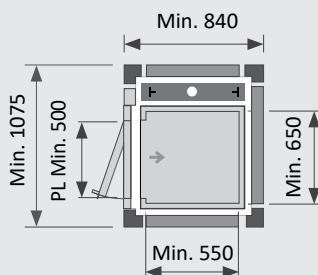

MAX DIMENSIONS

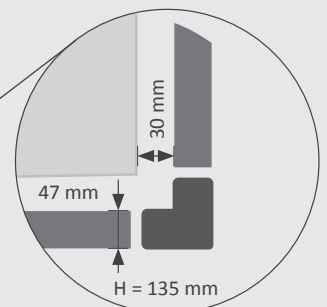
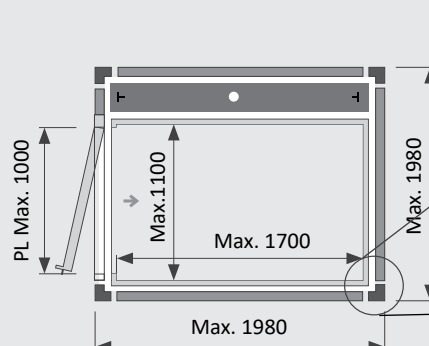

*Min. and max. reference values cannot be configured together (subject to feasibility study)

InDomo®



LIFTING ITALIA S.r.l.
Via Caduti del Lavoro, 16
43058 Bogolese di Sorbolo (Parma)
Tel. 0521 695311
www.liftingitalia.com



MADE IN ITALY

